



SPA PRE-DELIVERY GUIDE



www.calspas.com

Contents

Pre-Delivery and Installation Checklist	1
Planning the Best Location.....	2
Portable Spa Site Preparation	4
In-Ground Spa Site Preparation.....	4
Getting the Spa Into Your Yard.....	6
Electrical Requirements	8
<i>Electrical Requirements – US and Canada.....</i>	<i>8</i>
<i>Electrical Installation -- Europe</i>	<i>13</i>
Installing the In-Ground Shell	16
Equipment Pack Plumbing Connections (In-Ground Spas).....	17
<i>In-Ground Plumbing Connections</i>	<i>19</i>
<i>Electrical and Electronic Connection</i>	<i>21</i>
<i>Pouring the In-Ground Spa Deck</i>	<i>25</i>
Spa Technical Specifications	26

Copyright 2008-2009 LMS, Inc. All rights reserved. Duplication without written consent is strictly prohibited.

Cal Spas® is a registered trademark.

Due to continuous improvement programs, all models, operation, and/or specifications are subject to change without prior notice.

LTR20091024, Rev. A
12/15/08

CONTACT INFORMATION

For customer service, please contact your authorized dealer immediately. If you need additional information and/or assistance, please contact:

LMS Customer Service Department
1462 East Ninth Street
Pomona, CA 91766

Toll Free: 1-800-CAL-SPAS
Fax: 1-909-629-3890

www.calspas.com

Pre-Delivery and Installation Checklist

Most cities and counties require permits for exterior construction and electrical circuits. In addition, some communities have codes requiring residential barriers such as fencing and/or self-closing gates on property to prevent unsupervised access to the property by children under the age of 5. Your dealer can provide information on which permits may be required and how to obtain them prior to the delivery of your spa.

We strongly recommend you have a qualified, licensed contractor perform the installation of your in-ground or ported spa. The installation instructions contained in the manual are for the use of a qualified contractor or installer.

Consumers who choose to install their own in-ground spas bear sole responsibility for any performance or warranty issues and may void portions of their warranty as a result. For this reason, we strongly recommend they hire an experienced professional for their installation.

For additional operating and installation information, please see your selling dealer.

Portable Spa Pre-Delivery Checklist

Before Delivery	
	Plan your delivery route
	Choose a suitable location for the spa
	Lay a 3" - 4" concrete slab
	Install dedicated electrical supply
After Delivery	
	Place spa on slab
	Connect electrical components

In-Ground Spa Pre-Delivery Checklist

Before Delivery	
	Plan your delivery route
	Choose a suitable location for the shell and equipment pack
	Excavate the hole
	Install dedicated electrical supply
	Install dedicated NG line for gas heater
After Delivery	
	Install shell in ground
	Install equipment pack
	Connect plumbing
	Connect electrical components
	Pour the deck

Planning the Best Location

Safety first

Do not place your spa within 10 feet (3 m) of overhead power lines.

Make sure the spa is positioned so that access to the equipment compartment and all side panels will not be blocked. Be certain that your installation will meet all city and local safety codes and requirements.

Consider how you will use your spa

How you intend to use your spa will help you determine where you should position it. For example, will you use your spa for recreational or therapeutic purposes? If your spa is mainly used for family recreation, be sure to leave plenty of room around it for activity. If you will use it for relaxation and therapy, you'll probably want to create a specific mood around it.

Plan for your environment

If you live in a region where it snows in the winter or rains frequently, place the spa near a house entry. By doing this, you will have a place to change clothes and not be uncomfortable.

Consider your privacy

In a cold-weather climate, bare trees won't provide much privacy. Think of your spa's surroundings during all seasons to determine your best privacy options. Consider the view of your neighbors as well when you plan the location of your spa.

Provide a view with your spa

Think about the direction you will be facing when sitting in your spa. Do you have a special landscaped area in your yard that you find enjoyable? Perhaps there is an area that catches a soothing breeze during the day or a lovely sunset in the evening.

Keep your spa clean

Prevent dirt and contaminants from being tracked into your spa by placing a foot mat at the spa's entrance where the bather's can clean their feet before entering your spa. You may also consider keeping a small water-filled basin nearby for bathers to rinse their feet before entering your spa.

In planning your spa's location, consider a location where the path to and from the house can be kept clean and free of debris.

Allow for service access

Many people choose to install a decorative structure around their spa. If you are installing your spa with any type of structure on the outside, such as a gazebo, remember to allow access for service. It is always best to design special installations so that the spa can still be accessed.

Outdoor equipment pack (in-ground spas only)

The Designer Spa series requires an external equipment pack. When locating the outdoor equipment pack, you will want to consider the following:

- The equipment pack must be located within a maximum of 15 feet from the spa.
- Ensure the equipment running its normal filtration cycles does not make too much noise for spa owners and/or neighbors.
- Ensure the equipment can be easily serviced for filter cleaning and periodic inspections in the location chosen.
- If you are using a gas heater, you will need to consider wind and drafts as well as heater exhaust for proper heater placement. (See heater owner's manual for important location and safety information.)
- The equipment base and heater must be placed on either a 3 1/2" cement slab or 3" paving stones.
- Make sure the equipment area selected will not be in an area where water could run or stand.
- If the area receives direct sunlight, you will want to provide some protection for the equipment portion of the equipment pack.

The equipment pack and heater are delivered separately. Do not cover gas heaters unless properly vented. (See heater owner's manual for important safety information.)

Portable Spa Site Preparation

Your spa needs a solid and level foundation. The area that it sits on must be able to support the weight of the spa, with water and the occupants who use it. If the foundation is inadequate, it may shift or settle after the spa is in place, causing stress that could DAMAGE YOUR SPA SHELL AND FINISH.

Note: Damage caused by inadequate or improper foundation support is not covered by the warranty. It is the responsibility of the spa owner to provide a proper foundation for the spa.

Place the spa on an elevated foundation (preferably a 3" - 4" concrete slab). Pavers, gravel, brick, sand, timbers or dirt foundations are **not** adequate to support the spa. If you are installing the spa indoors, pay close attention to the flooring beneath it. Choose flooring that will not be damaged or stained.

If you are installing your spa on an elevated wood deck or other structure, it is highly recommended that you consult a structural engineer or contractor to ensure the structure will support the weight of 150 pounds per square foot.

To properly identify the weight of your new spa when full, remember water weighs 8.33 lbs. per gallon. For example, an average 8' spa holds approximately 500 gallons of water. Using this formula, you will find that the weight of the water alone is 4,165 lbs. Combined with the dry weight of the spa you will note that this spa will weigh approximately 5,000 lbs. when full of water.

Note: It is strongly recommended that a qualified, licensed contractor prepare the foundation for your spa.

Your Cal Spas retailer can help you with your foundation and more. Your retailer has a wealth of information and experience about how to get the most out of your spa and can provide you with a full line of accessories that are designed to complement your spa and increase your enjoyment.

In-Ground Spa Site Preparation

- Ensure there is enough room for the spa and equipment.
- The equipment pack must be located within a maximum of 15 feet from the spa.
- Plan for proper electrical and gas service to both the equipment area and spa side.
- Ensure the required flat, level foundation can be constructed in the area chosen.

- The spa must be properly back-filled with wet sand, underneath and on all four sides.
- The final architecture must include permanent ground coverage within a 10 feet radius of the spa.
- Never place any spa in a sealed area. Water must be able either to be absorbed into the surrounding area or channeled away. Water build-up under and/or around the spa, will cause the spa to float out of the ground.

Grading Prior to Excavation

Selection of the Designer Spas site will determine how much grading will have to be accomplished prior to the actual dig for the spa. Naturally, a level area is best because it will require the least amount of preparation for the dig, but in many cases there is no level area, therefore, the site must be prepared to accept the Spa prior to dig. The spa site should be elevated slightly higher than the surrounding area

When dealing with slopes, the severity of the slope will determine if retaining walls must be built in order to have a level area for the spa. If the slope is relatively minor, contact your local building safety.

Site Excavation – Hard Bottom

For hard bottom placement for in-ground spas, you will need a smooth and flat concrete surface at least 4" thick as large as the bottom contact points. Be sure not to seal the bottom off and making a sealed box. You will need adequate water drainage for escape under the spa. A gravel beds around the concrete base will help with this.

Site Excavation – Sand Bottom

With the spa area and all elevations planned including your decided type of decking, you are now ready to proceed with the dig. An ideal excavation is one that is as close as possible to the dimensions of the spa shell, but with the following rules in mind. The excavation should be 2" to 4" deeper than the actual spa for your sand bed. The sand bed is to level the spa shell and provide a perfect support base with no voids when the spa is lowered into the hole. Your excavation should be approximately one foot longer and one foot wider than the spa shell. This will allow for a six inch over dig all the way around the spa once it is in place. Additional hand excavation will be required to insure the skimmer will fit in the excavation when attached to the spa.

Sand or rock dust must be used to bed the shell into the excavation and for backfill. In no event is dirt to be used. One of the easiest ways to know how much sand is needed to be placed on the bottom of the excavation is to set a grade stake at all four corners, and one on each side of the center line in the bottom of the hole. If there are areas that are deeper than 2" to 4", these can be filled with sand and are of no consequence.

Getting the Spa Into Your Yard

Check the Dimensions of Your New Spa

The specification chart on page 26 lists your spa's model and its dimension as it sits on the delivery cart. During delivery, the spa must remain on the delivery cart at all times. Compare the dimensions to the width of the gates, sidewalks, and doorways along the delivery route. It may be necessary for you to remove a gate or partially remove a fence in order to provide an unobstructed passageway to the installation location.

Plan the Delivery Route

Consider the following when planning your delivery route:

- Check the width of gates, doors and sidewalks to make sure your spa will pass through unobstructed. You may have to remove a gate or part of a fence to allow for adequate width clearance.
- Are there low roof eaves, overhanging branches or rain gutters that could be an obstruction to overhead clearance?
- 8' spas need at least 42" wide gate and 9' height clearance.
- If the delivery route will require a 90° turn, check the measurements at the turn to ensure the spa will fit.
- Are there protruding gas meters, water meters or A/C units on your home which will cause obstructions along the delivery path to your yard?
- Are there stairs in your delivery route? If so, you must consult your Cal Spas dealer prior to delivery to make adequate preparations.

Special Circumstances

The use of a crane for delivery and installation may become necessary if you are unable to provide an adequate delivery route. It is used primarily to avoid injury to your spa, your property or to delivery personnel. Your Cal Spas dealer may be able to assist you with the arrangements. If your spa delivery requires the use of a crane, the cost of a crane is generally not included in the standard delivery service.

Check your width clearance

- Check all gates
- Protruding electric meters
- Gas meters
- A/C units

Do you have sufficient overhead clearance?

Check low roof eaves, overhanging branches, rain gutters

Is the path clear?

Move away branches, dog houses, firewood, etc.

If there is a 90° turn, can we clear it?
(The spa will not bend.)

No stairs! If there are stairs in the delivery route, consult the dealer.

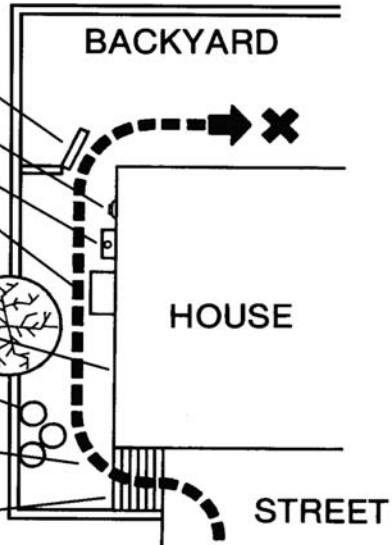

Electrical Requirements

Electrical Requirements – US and Canada

240 Volt Electrical Installation

All 240V spas must be permanently connected (hardwired) to the power supply. These instructions describe the only acceptable electrical wiring procedure. Spas wired in any other way will void your warranty and may result in serious injury.

This is the only acceptable electrical wiring procedure. Spas wired in any other way will void your warranty. See the wiring diagram on page 11.

When installed in the United States, the electrical wiring of this spa must meet the requirements of National Electric Code, ANSI/NFPA 70-2008 and any applicable local, state, and federal codes. The electrical circuit must be installed by an electrical contractor and approved by a local building / electrical inspector.

GFCI and Wiring Requirements

The power supplied to the spa must be on a dedicated GFCI protected circuit as required by ANSI/NFPA 70 with no other appliances or lights sharing the power.

Use copper wire with THHN insulation. Do not use aluminum wire.

Use the table on the next page to determine your GFCI and wiring requirements.

When NEC requires the use of wires larger than #6 AWG, install a junction box near the spa and use #6 AWG wire between the junction box and the spa.

Wire runs over 85 feet must increase wire gauge to the next lower number. For example: A normal 50 amp GFCI with four #8 AWG Copper wires run over 85 feet would require you to go to four #6 AWG copper wires.

Read and follow the heater manufacturer's safety and installation instructions prior to installation and operation. Incorrect installation may damage the heater and void its warranty.



	Spa Model	GFCI Required	Wires Required
Portable Spas	All 240V spas (except 6300 control boxes requiring high amperage - see below)	One 50 amp GFCI	Four #8 AWG copper wires
	Spas with the 6300 control box (when high amperage is selected on circuit board) SEE CONFIGURATION INSTRUCTIONS ON NEXT PAGE.	One 60 amp GFCI	Four #8 AWG copper wires

Ultimate Fitness Spas	F2400 spa with one 5.5 kW heater	One 50 amp GFCI	Four #8 AWG copper wires
	F2400 and FP2500 spas with two 5.5 kW heaters	Service 1: One 60 amp GFCI Service 2: One 30 amp GFCI	Service 1: Four #8 AWG copper wires Service 2: Three #8 AWG copper wires
	FP4700 spa	Service 1 (swim side): One 60 amp GFCI Service 2 (swim side): One 30 amp GFCI Service 3 (spa side): One 40 amp GFCI	Service 1: Four #8 AWG copper wires Service 2: Three #8 AWG copper wires Service 3: Four #8 AWG copper wires

In-Ground Spas	Designer in-ground spas with one 5.5 kW heater	One 50 amp GFCI	Four #8 AWG copper wires
	Designer in-ground spas with two 5.5 kW heaters	Service 1: One 50 amp GFCI Service 2: One 30 amp GFCI	Service 1: Four #8 AWG copper wires Service 2: Three #8 AWG copper wires
	DIJ407 spa	Service 1: One 60 amp GFCI Service 2: One 30 amp GFCI	Service 1: Four #8 AWG copper wires Service 2: Three #8 AWG copper wires

Testing the GFCI Breaker

Test the GFCI breaker prior to first use and periodically when the spa is powered. To test the GFCI breaker follow these instructions (spa should be operating):

1. Press the TEST button on the GFCI. The GFCI will trip and the spa will shut off.
2. Reset the GFCI breaker by switching the breaker to the full OFF position, wait a moment, then turn the breaker back on. The spa should have power again.

Configuring the 6300 Control System

The 6300 control system requires higher power than other 240V systems. Dip switch #10 is factory set in the ON position. This causes the heater to shut off when any pump is running in high speed. To allow the heater to continue operating, dip switch #10 must be set to the OFF position. To ensure your spa functions properly, ensure the following steps are performed before starting your spa:

- When installing the electrical system, use a 60 amp GFCI. Follow the GFCI wiring diagram on the next page.
- Have your dealer or installer set dip switch #10 to the OFF position on the circuit board as shown below.

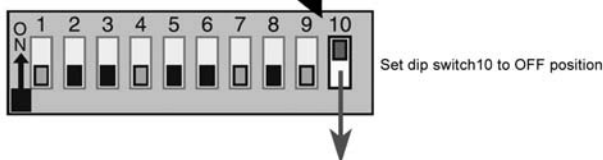
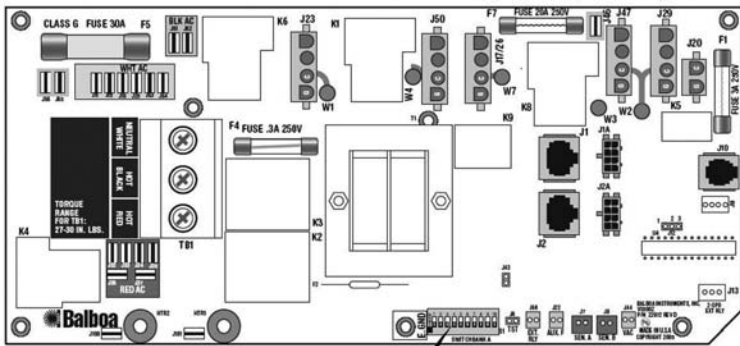

GFCI Wiring Diagram

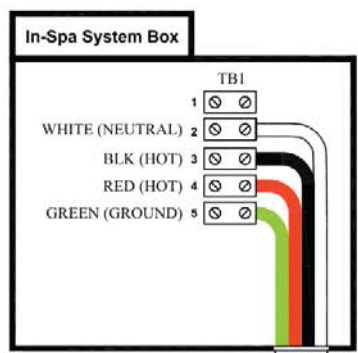
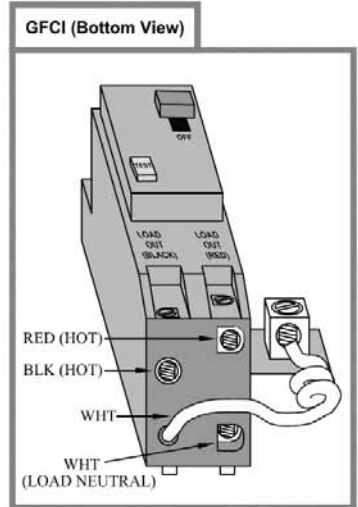
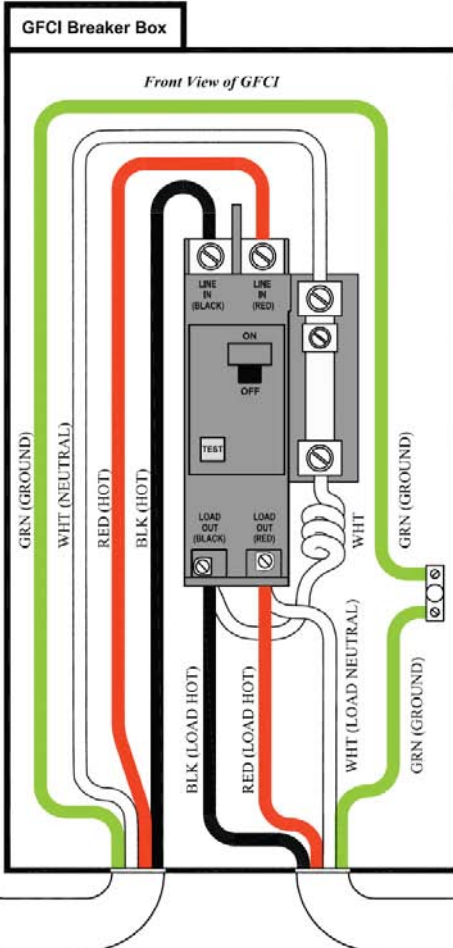
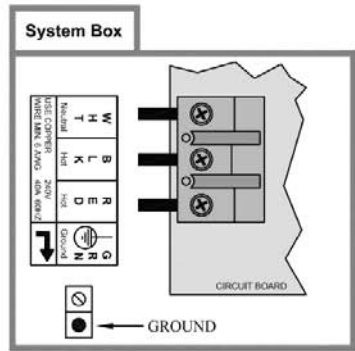
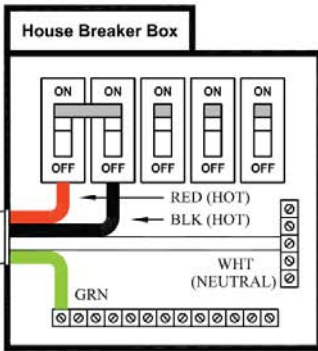

120 Volt Electrical Installation

Always follow applicable local, state and federal codes and guidelines.

Use only a dedicated electrical line with a 20-amp breaker.

Cord-and-plug connections may not use a cord longer than 15 ft (4.6 m) and must be plugged into a dedicated 20-amp GFCI connection. Do not use extension cords!

Always use a weatherproof-covered receptacle.

Receptacle shall be located not less than 5 ft (1.5 m) from and not exceeding 10 ft (3.0 m) from the inside wall of the spa.

Do not bury the power cord.

If your cord becomes damaged, replace it before next usage.

All 120V spas must have a GFCI. This can be either a 20-amp GFCI receptacle or a GFCI cord and plug kit as shown at right (CKIT110 - P/N ELE09700086).



Testing the GFCI Breaker

Test the GFCI plug prior to first use and periodically when the spa is powered. To test the GFCI plug version, follow these instructions. (Spa should already be plugged in and operational.)

1. Press the TEST button on the GFCI. The GFCI will trip and the spa will stop operating.
2. Press the RESET button on the GFCI. The GFCI will reset and the spa will turn back on.

The spa is now safe to use.

If the GFCI trips while the spa is in use, press the RESET button. If the GFCI does not reset, unplug the spa and call your local Cal Spas dealer for service. **DO NOT USE THE SPA!**

Electrical Installation -- Europe

230 Volt Electrical Installation

All 230V spas must be permanently connected (hardwired) to the power supply. These instructions describe the only acceptable electrical wiring procedure. Spas wired in any other way will void your warranty and may result in serious injury.

This is the only acceptable electrical wiring procedure. Spas wired in any other way will void your warranty. See the wiring diagram on page 15.

The electrical wiring of this spa must meet the requirements of any applicable local, state, and federal codes. The electrical circuit must be installed by an electrical contractor and approved by a local building / electrical inspector.

RCD and Wiring Requirements

The power supplied to the spa must be on a dedicated RCD protected circuit with no other appliances or lights sharing the power.

Use copper wire with THHN insulation. Do not use aluminum wire.

Use the table on the next page to determine your GFCI and wiring requirements.

When wires larger than #6 AWG are required, install a junction box near the spa and use #6 AWG wire between the junction box and the spa.

Wire runs over 85 feet must increase wire gauge to the next lower number. For example: A normal 50 amp RCD with four #8 AWG copper wires run over 85 feet would require you to go to four #6 AWG copper wires.

Testing the RCD Breaker

Test the RCD breaker prior to first use and periodically when the spa is powered. To test the RCD breaker follow these instructions (spa should be operating):

1. Press the TEST button on the RCD. The RCD will trip and the spa will shut off.
2. Reset the RCD breaker by switching the breaker to the full OFF position, wait a moment, then turn the breaker back on. The spa should have power again.



	Spa Model	GFCI Required	Wires Required
Portable Spas	All 230V spas (except 6205 control boxes requiring high amperage - see below)	One 32 amp RCD or two 16 amp RCDs	Three #10 AWG copper wires
	Spas with the 6300 control box (when high amperage is selected on circuit board) SEE CONFIGURATION INSTRUCTIONS ON NEXT PAGE.	One 32 amp RCD or two 16 amp RCDs	Three #10 AWG copper wires

Ultimate Fitness Spas	F2400 spas with one 5.5 kW heater	One 32 amp RCD or two 16 amp RCDs	Three #10 AWG copper wires
	FP2500 spa with one 5.5 kW heater and one 3 kW heater	Service 1: One 32 amp RCD or two 16 amp RCDs Service 2: One 32 amp RCD	Service 1: Three #10 AWG copper wires Service 2: Three #10 AWG copper wires
	FP4700 spa	Service 1 (swim side): One 32 amp RCD Service 2 (swim side): One 32 amp RCD Service 3 (spa side): One 32 amp RCD	Service 1: Three #10 AWG copper wires Service 2: Three #10 AWG copper wires Service 3: Three #10 AWG copper wires

In-Ground Spas	Designer in-ground spas with one 3 kW heater	One 32 amp RCD or two 16 amp RCDs	Three #10 AWG copper wires
	Designer in-ground spa with one 3 kW heater and one 5.5 kW heater	Service 1: One 32 amp RCD or two 16 amp RCDs Service 2: One 32 amp RCD	Service 1: Three #10 AWG copper wires Service 2: Three #10 AWG copper wires

RCD Wiring Diagram

Value M-7 and 2000LE M-7 System

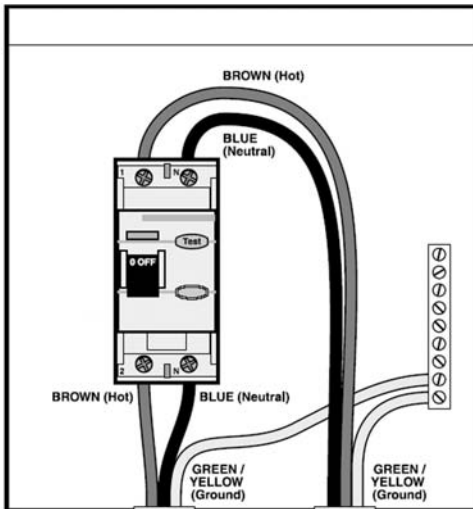
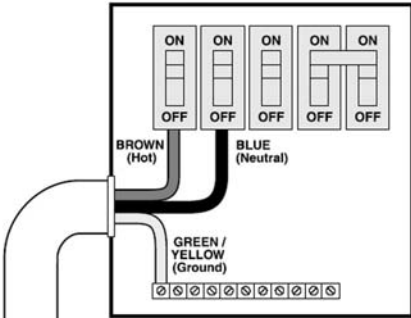
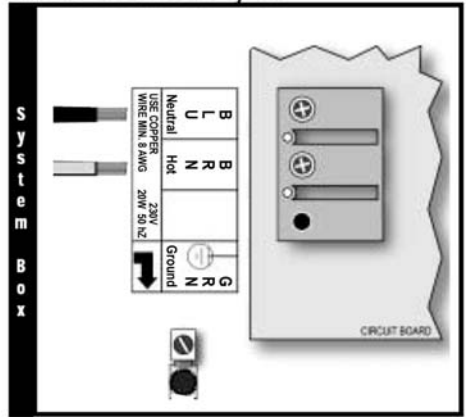

Elite System

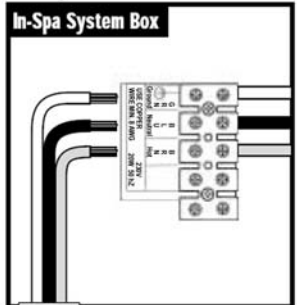

Installing the In-Ground Shell

In-Ground Spa Deck Requirements

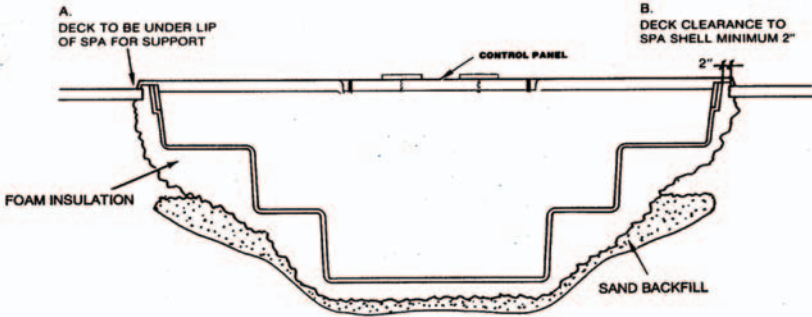

- A.** Deck must go under lip of spa uniformly for proper lip support. Lip is not to bear any weight from spa. Deck is only to stop lip from flexing when stepped or sat on.
- B.** Deck must not be poured up against spa, since cement expands and contracts as temperature changes. Leave a gap of 2" from shell for proper structure protection.

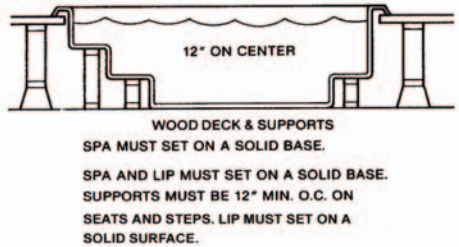
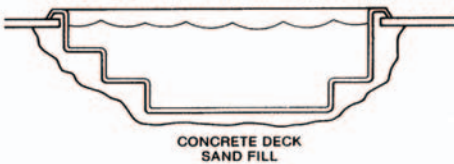

Equipment Pack Plumbing Connections (In-Ground Spas)

The example shown below is typical for a system with two pumps with external heater and external filter.

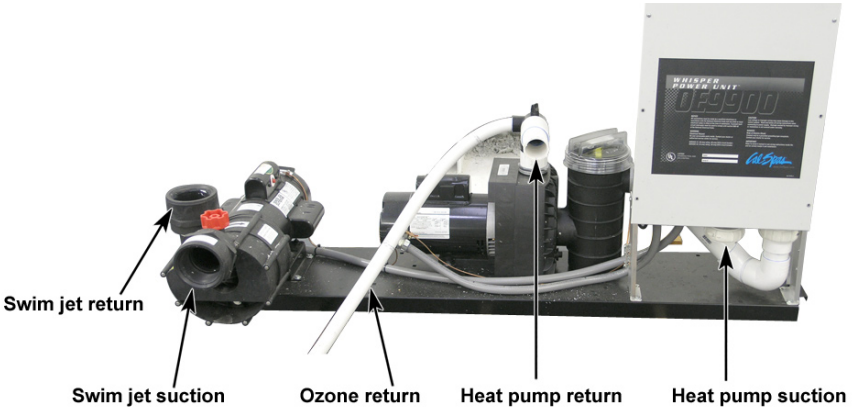

Designer Spa Specifications

DIJ401 and DIJ405:

Equipment pack weight = 250 lbs.

DIJ407:

Equipment pack weight = 300 lbs.

2.5 HP heat pump

4 HP swim pump

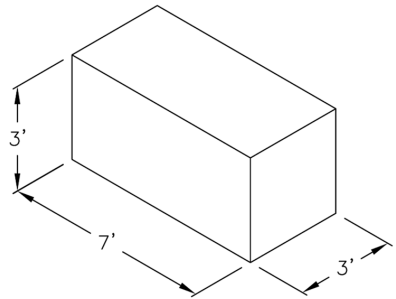

EQUIPMENT PACK DIMENSIONS

Note: Equipment pack cannot exceed 15 feet from spa.

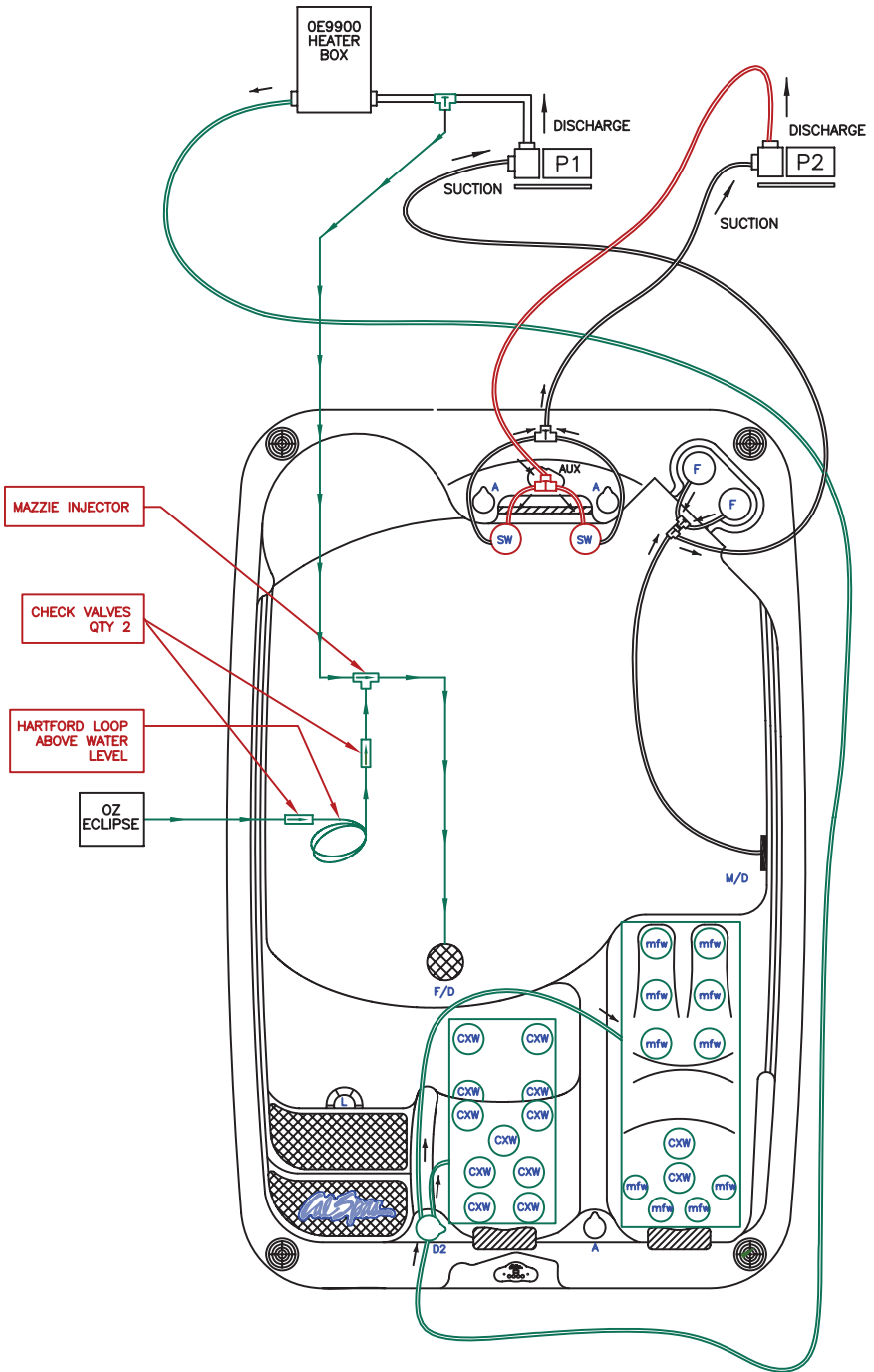

In-Ground Plumbing Connections

IMPORTANT! Always check local codes prior to any in-ground spa installation.

Once the spa and equipment are properly located, you will want to lay out the plumbing run.

Trenches should be deep and wide enough to allow all pipes to be buried below the frost line and should be in as straight a line from the spa to the equipment as possible. Check local code requirements for underground pipes. Always know what is under the ground before you dig anywhere.

You will need 2" flex or PVC lines for your suction, intake, and air line. In ground spas have marked intake and suction lines, making it easy find and connect to and from the spa and equipment pack.

The plumbing run should not be any longer than 15 feet to maximize water pressure. Another way to maximize water pressure is to limit (or even eliminate) the use of 90° elbows in your plumbing run. A more direct plumbing run using 45° elbows is more efficient, and promotes increased water pressure.

Identifying Plumbing Lines

The spa's plumbing lines are clearly marked during water testing at the factory. This is done to assist installers in properly identifying the installation. We still recommend that the installers verify plumbing lines prior to gluing. This can be done by using one of the following techniques.

Air Test

The air test requires a wet/dry vacuum. Locate the plumbing line you wish to identify and secure the vacuum hose to cut open end. Turn on the vacuum, enter the spa and listen for vacuum suction sound from inside the spa side filter canister. If you hear the suction sound in the canister, the line is properly marked and can be connected to the suction side of the pump on the equipment pack.

Water Test

The water test requires a garden hose and water source. Locate the plumbing line you wish to identify and secure the outlet side of the garden hose to cut open end. Turn on the water supply to the garden hose, enter the spa and look for water inside the spa side filter canister. If you see water in the canister the line is properly marked and can be connected to the suction side of the pump on the equipment pack.

If any plumbing line is not properly marked or not marked at all, follow either the air or water test procedure until all lines are identified prior to gluing.

NOTE: Once complete, water test the plumbing run for at least three days prior to covering any plumbing trenches and back-filling spa cavity completely.

NOTE: Some local inspectors require pressure testing the plumbing lines. Although the spa is pressure tested at the factory, local inspectors may insist on pressure testing the plumbing run between the spa and equipment pack.

Gate/Slice Valves

The use of gate valves is recommended on all plumbing lines (both suction and return lines). These valves are used to contain the spa's water in either the equipment or the spa. This will assist in the pump priming process and future servicing without needing to drain the spa.

NOTE: When draining the spa to perform maintenance, always close the gate valves prior to draining. This will maintain the pumps prime.

Connecting Plumbing to Remote Equipment

Connecting the plumbing from the spa to the equipment pack must be performed in accordance to local and city codes.

NOTE: Most codes require plumbing to be rigid PVC schedule 40 or heavier in both above and below ground installations. In most cases, the use of flexible PVC plumbing is acceptable when properly buried in trenches.

Most water plumbing lines are 2" or larger and must be schedule 40 or heavier PVC. When plumbing, minimize the use of 90° elbows as much as possible. The use of 45° elbows will increase the amount of jet pressure you will have over the use of 90° elbows.

The plumbing on the spa shell is labeled by the factory in the following manner:

Pump 1 Suction: 2" line that connects the spa filter and bottom drain assembly to the front of pump 1.

Pump 1 Return: 2" line that connects the top of pump 1, through the equipment filter and heater back to selected jets in the spa.

Pump 2 Suction: 2" line that connects the spa filter and bottom drain assembly to the front of pump 2.

Pump 2 Return: 2" line that connects the top of pump 2 back to selected jets in the spa.

Ozone Line: 1" line that connects to a 1" flexible line extending off the bottom of the equipment pack filter canister through an ozone injector (If ozone equipped) and connected to ozone port on the spa.

Air Blower: 1 1/2" line that is plumbed out of the air blower (located on the equipment pack) and extended up 18" above the spas water level to prevent water flooding the air blower.

Air Venturi: 1/2" line that is plumbed 18" above the spa's water level.

Topside Control Panel and Temp Sensor: 1" line that connects to the bottom of the control box located on the equipment pack.

Electrical and Electronic Connection

Remote Equipment Topside Control Panel

The next few steps to complete the installation should be performed along with installation of the temperature sensor and 12V spa light wiring (if applicable). All of these components are generally installed using the same conduit.

1. Locate the topside control panel extension loom in the control box mounted with the equipment pack. This extension loom and attached black terminal connector (see figure at right) will be used to connect the topside control panel to the control box.



2. Connect one end of the black terminal connector to the topside control panel cable.
3. Connect the other end of the terminal connector to the extension loom.

NOTE: This connection must be kept dry. We recommend that a waterproof junction box be used in installations where moisture could penetrate this terminal connector.

4. Lay out the extension loom to verify that you have enough length to reach the control box. Remember that conduit runs are not generally run in a straight line. Every bend, and up and down run consumes line length. Take this into consideration when verifying electrical and plumbing runs.
5. Connect the extension loom to the control panel location on the circuit board located inside the control box. You will also need to connect both the temperature and high limit sensors to the circuit board prior to testing. (See the temperature and high limit installation instruction on the next page for proper identification and see the wiring diagram on the inside cover of the control box for proper placement.)
6. Turn on the power supply to the spa equipment and briefly test all functions on the topside control panel to verify that both connections and extension loom are in working order before proceeding with the installation.

NOTE: Circuit board programming will not allow spa operation without both the temperature and high limit sensors being properly connected to the circuit board.

7. Once topside panel operation is verified. Turn off power, disconnect the extension loom from the circuit board and GENTLY route through conduit to complete installation.

NOTE: This loom and its connector are not meant to withstand heavy pulling. Make sure, when routing the extension loom and temperature sensor lines through conduit, you exercise extreme caution.

Once properly run through the conduit, repeat steps 5 and 6 above.

In-Ground Spa Light Installation Instructions

On spas ordered with in-ground lights, the factory installs the light niche for you. The next steps of installation should be performed by a qualified licensed electrician.

Always read and follow light manufacturer's safety and installation instructions prior to installation and operation. Incorrect installation may damage the light and void its warranty.

The light circuit must be on a GFCI protected service (alone or with a switch).

The water resistant junction box (or for 12 volt models, the low voltage transformer) must be located:

- at least 8" (20 cm) above water level
- at least 4" (10 cm) above ground level, and
- at least 48" (121 cm) away from the spa.

See figure below.

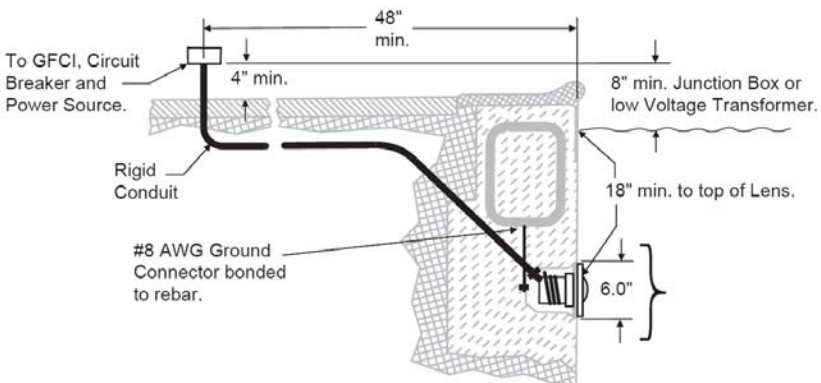

Light niche and any metallic items in a 5' (152 cm) radius must be properly bonded with #8 AWG grounding wire.

1. Connect rigid conduit to the 3/4" hub located at the back of the light niche and run to a water resistant junction box (or for 12 volt models to a low voltage transformer) no further than 25' (7.6m). Remember this is a water cooled light, so the conduit and all connections must be leakproof.
2. Feed the light cord through the rigid conduit to the junction box, leaving at least 4 feet of cord at the end of the light fixture. This slack in the light cord will allow servicing without draining the spa in the future.
3. Wrap light cord slack around back of light housing and attach light to niche with mounting screw.
4. Cut the cord at the junction box, leaving at least 6" (15 cm) of cord to make connections.
5. Strip 6" (15 cm) of the out cord jacket to expose the three insulated wires. Be careful not to damage the insulation on the three inner wires.
6. Connect the three wires to the corresponding circuit wires in the junction box and secure the junction box cover in place.
7. Replace the light assembly in the niche and tighten the special pilot screw.
8. Fill the spa until the underwater light is completely submerged in water before operating the light for more than 10 seconds. Turn on the main switch or circuit breaker, as well as the spa light control, to check for proper operation

Important: Make sure spa light is submerged in at least 18" of water prior to testing.

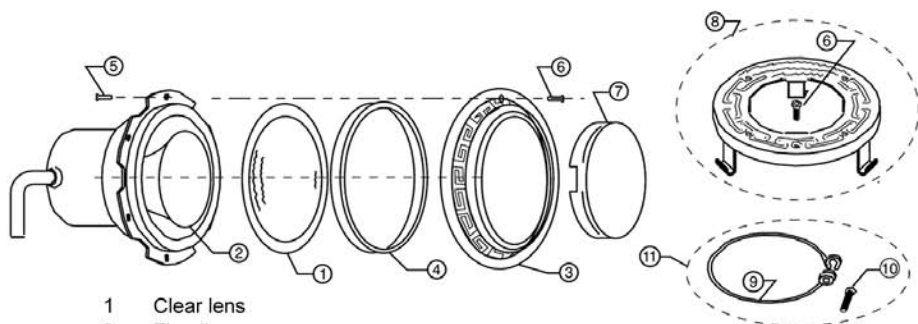
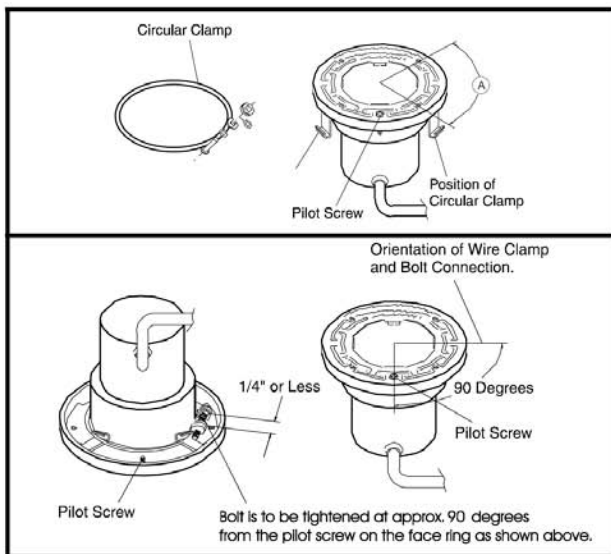

- 1 Clear lens
- 2 Floodlamp
- 3 Face ring, chrome-brass
- 4 Gasket, 4" diameter
- 5 Screw, stainless steel, 10-24 x 3/8" (6 required)
- 6 Pilot screw with captive gum washer
- 7 Kwik-change color lens
- 8 Face ring assembly
- 9 Wire spring clamp
- 10 1/4-20 x 5/8" bolt
- 11 Uni-tension wire assembly, stainless steel with welded nut

⚠ WARNING

Use only the special pilot screw provided with this underwater light. This screw mounts and electrically grounds the housing securely to the mounting ring and wet niche. Failure to use the screw provided could create an electrical hazard which could result in death or serious injury to pool users, installers or others due to electrical shock.

Pouring the In-Ground Spa Deck

It is recommended that all electrical hook ups and all plumbing be completed before pouring the concrete. Make certain all electrical inspections on lights, bonding and all other electrical work have been completed and checked off by the local inspectors prior to proceeding with your concrete or finish work. It is a good idea to run the spa for at least 24 hours before pouring the concrete to insure there are no leaks. We understand you want to enjoy your spa now, but a 24-hour period with your spa running will let you know of any problems before they will be extremely hard to fix.

The type of decking you have selected will have determined the grade of the spa. If you are pouring a regular deck up to the spas coping, then the top of the coping should be 4" above the surrounding area. In either event, it is recommended to dig out an area around the spa exposing the flange of the coping and just under it. This is important, as concrete should be packed under and over the flange of the spa, as the deck is poured. This will lock the spa into the concrete and provide for a much stronger bond of the spa to the deck. It will also eliminate cracking of the deck where it meets the spa.

When setting your outside forms, remember you want any water from rain or splash out to run off the deck, not into the spa. If your deck is going to tie into an existing deck, than some type of drain system should be planned to handle the run off. Proper drainage planning is very important.

An experienced concrete finisher should always be used when pouring spa decks, especially when you are doing a cantilevered deck, as the forms must be taken off at the proper time to allow finishing of the inside of the form.

Spa Technical Specifications

All sizes on this chart represent outside dimensions. Due to our continuous improvements, specifications, size and pricing are subject to change without prior notice.

Avalon Series						
Model	Width	Length	Depth	Gallons	Dry Weight	Filled Weight
A515	84"	64"	32"	325	600 Lbs.	3307 Lbs.
A526	84"	64"	32"	325	600 Lbs.	3307 Lbs.
A534	84"	64"	32"	325	600 Lbs.	3307 Lbs.
A726B	84"	84"	39½"	425	850 Lbs.	4390 Lbs.
A726L	84"	84"	39½"	425	850 Lbs.	4390 Lbs.
A734B	84"	84"	39½"	425	850 Lbs.	4390 Lbs.
A734L	84"	84"	39½"	425	850 Lbs.	4390 Lbs.
A744B	84"	84"	39½"	425	850 Lbs.	4390 Lbs.
A744L	84"	84"	39½"	425	850 Lbs.	4390 Lbs.
A826B	93"	93"	39½"	450	900 Lbs.	4648 Lbs.
A826L	93"	93"	39½"	450	900 Lbs.	4648 Lbs.
A834B	93"	93"	39½"	450	900 Lbs.	4648 Lbs.
A834L	93"	93"	39½"	450	900 Lbs.	4648 Lbs.
A844B	93"	93"	39½"	450	900 Lbs.	4648 Lbs.
A844L	93"	93"	39½"	450	900 Lbs.	4648 Lbs.
A857B	93"	93"	39½"	450	900 Lbs.	4648 Lbs.
A857L	93"	93"	39½"	450	900 Lbs.	4648 Lbs.
A969L	93"	130"	39½"	800	1200 Lbs.	7864 Lbs.

Designer Series						
Model	Width	Length	Depth	Gallons	Dry Weight	Filled Weight
DI-401	93"	Round	34"	500	500 Lbs.	4665 Lbs.
DI-405	130"	93"	33"	900	750 Lbs.	8247 Lbs.
DI-407	93"	202"	48½"	2500	1300 Lbs.	22125 Lbs.

Classic Series						
Model	Width	Length	Depth	Gallons	Dry Weight	Filled Weight
CL-25	64"	84"	32"	125	535 Lbs.	1576 Lbs.
CP-36	84"	84"	39½"	425	850 Lbs.	4390 Lbs.
CT-36	84"	84"	39½"	425	850 Lbs.	4390 Lbs.
CP-50	84"	84"	39½"	425	850 Lbs.	4390 Lbs.
CT-50	84"	84"	39½"	425	850 Lbs.	4390 Lbs.
CT-64	84"	84"	39½"	425	850 Lbs.	4390 Lbs.
CP-65	84"	84"	39½"	425	850 Lbs.	4390 Lbs.
CV-35	93"	84"	39½"	450	900 Lbs.	4648 Lbs.
CA-65	93"	93"	39½"	450	900 Lbs.	4648 Lbs.
CA-36	93"	93"	39½"	450	900 Lbs.	4648 Lbs.
CBA-36	93"	93"	39½"	450	900 Lbs.	4648 Lbs.
CD-46	93"	93"	39½"	450	900 Lbs.	4648 Lbs.
CM-47	93"	93"	39½"	450	900 Lbs.	4648 Lbs.
CA-50	93"	93"	39½"	450	900 Lbs.	4648 Lbs.
CBA-50	93"	93"	39½"	450	900 Lbs.	4648 Lbs.
CBA-64	93"	93"	39½"	450	900 Lbs.	4648 Lbs.
CN-50	93"	130"	39½"	800	1200 Lbs.	7864 Lbs.
CN-65	93"	130"	39½"	800	1200 Lbs.	7864 Lbs.
CE-57	93"	138"	39½"	900	1100 Lbs.	8595 Lbs.

Galaxy Series						
Model	Width	Length	Depth	Gallons	Dry Weight	Filled Weight
GX-49	93"	93"	39½"	450	900 Lbs.	4648 Lbs.

Family II Series						
Model	Width	Length	Depth	Gallons	Dry Weight	Filled Weight
F515R	78"	Round	36"	300	350 Lbs.	2849 Lbs.
F518S	43"	83"	32"	100	250 Lbs.	1083 Lbs.
F520B	54"	78"	31"	125	350 Lbs.	1391 Lbs.
F730B	84"	84"	35"	425	800 Lbs.	4340 Lbs.
F730L	84"	84"	35"	425	800 Lbs.	4340 Lbs.
F732B	84"	84"	35"	425	800 Lbs.	4340 Lbs.
F732L	84"	84"	35"	425	800 Lbs.	4340 Lbs.
F745B	84"	84"	35"	425	800 Lbs.	4340 Lbs.
F745L	84"	84"	35"	425	800 Lbs.	4340 Lbs.
F748L	84"	84"	35"	425	800 Lbs.	4340 Lbs.
F830B	93"	93"	35"	450	900 Lbs.	4648 Lbs.
F830L	93"	93"	35"	450	900 Lbs.	4648 Lbs.
F845B	93"	93"	35"	450	900 Lbs.	4648 Lbs.
F845L	93"	93"	35"	450	900 Lbs.	4648 Lbs.
F848L	93"	93"	35"	450	900 Lbs.	4648 Lbs.
F864L	93"	93"	35"	450	900 Lbs.	4648 Lbs.

Escape Series						
Model	Width	Length	Depth	Gallons	Dry Weight	Filled Weight
EIII732B	84"	84"	39½"	425	800 Lbs.	4340 Lbs.
EIII732L	84"	84"	39½"	425	800 Lbs.	4340 Lbs.
EIII748L	84"	84"	39½"	425	800 Lbs.	4340 Lbs.
EIII848L	93"	93"	39½"	450	900 Lbs.	4650 Lbs.
EIII864L	93"	93"	39½"	450	900 Lbs.	4650 Lbs.

Ultimate Fitness and Fitness Pro Series						
Model	Width	Length	Depth	Gallons	Dry Weight	Filled Weight
F854	93"	93"	52"	650	1500 Lbs.	6914 Lbs.
F1257	96"	144"	52"	2000	1600 Lbs.	18260 Lbs.
FP1455	96"	174"	52"	2500	2000 Lbs.	22825 Lbs.
FP1755	96"	203"	52"	2500	2000 Lbs.	22825 Lbs.
F2400	96"	170"	52"	2000	1800 Lbs.	18460 Lbs.
FP2500	96"	206"	51"	2500	2000 Lbs.	22825 Lbs.
FP4700	96"	202"	52"	2000 / 285	2950 Lbs.	21985 Lbs.

Victory Extreme Series						
Model	Width	Length	Depth	Gallons	Dry Weight	Filled Weight
VX-901	72"	72"	30"	130	600 Lbs.	1583 Lbs.
VX-624B	76"	84"	34"	325	730 Lbs.	3437 Lbs.
VX-724L	78"	84"	32"	340	740 Lbs.	3572 Lbs.
VX-726B	84"	84"	39½"	425	800 Lbs.	4340 Lbs.
VX-726L	84"	84"	39½"	425	800 Lbs.	4340 Lbs.
VX-740L	84"	84"	39½"	425	800 Lbs.	4340 Lbs.
VX-834B	93"	93"	39½"	425	800 Lbs.	4340 Lbs.
VX-834L	93"	93"	39½"	425	800 Lbs.	4340 Lbs.
VX-848L	93"	93"	39½"	425	800 Lbs.	4340 Lbs.
VX-848B	93"	93"	39½"	450	900 Lbs.	4648 Lbs.
VX-861B	93"	93"	39½"	450	900 Lbs.	4648 Lbs.
VX-861L	93"	93"	39½"	450	900 Lbs.	4648 Lbs.



LMS Customer Service Department
1462 East Ninth Street
Pomona, CA 91766

Toll Free: 1-800-CAL-SPAS
Fax: 1-909-629-3890

www.calspas.com